

# BRASILIA VERTICAL

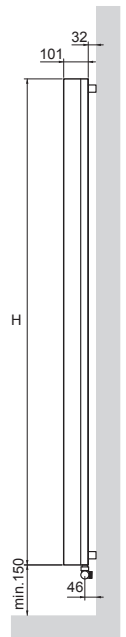

design by Massimo Iosa Ghini

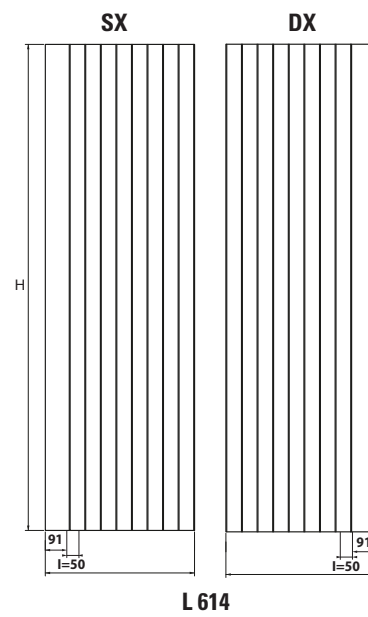
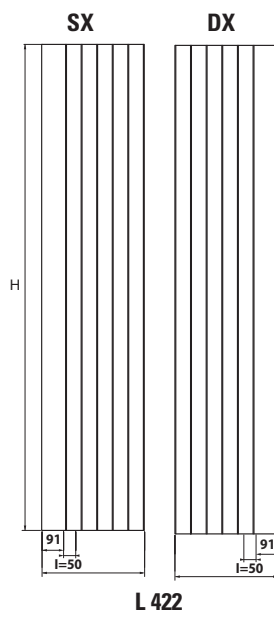
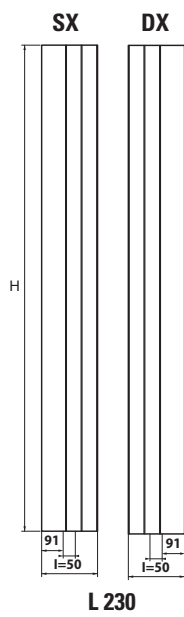
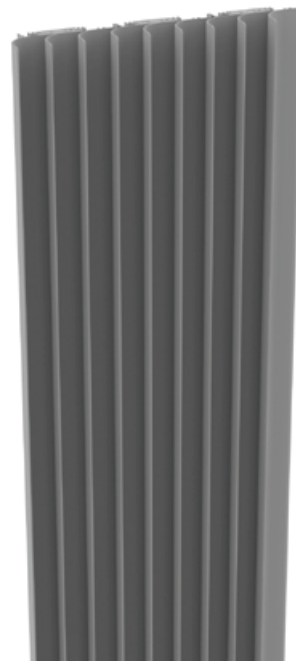
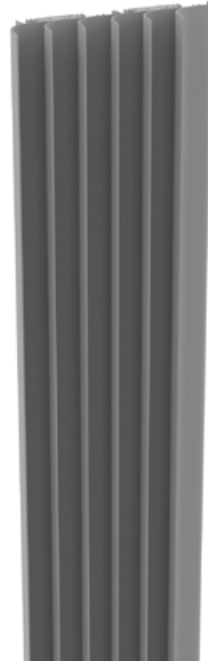

Interasse dal centro foro al muro 46 mm.  
Distance between hole center and wall 46 mm.  
Distance du centre du trou au mur 46 mm.  
Abstand zwischen Lochmitte und Wand 46 mm.  
Distancia entre el centro del agujero y el muro 46 mm.  
Расстояние между центром отверстия и стеной - 46 мм.

codice allaccio <b>SX</b> code connection <b>SX</b> code branchement <b>SX</b> Artikel Nr. anschliess <b>SX</b> codigo empalme <b>SX</b> код соединения <b>SX</b>	codice allaccio <b>DX</b> code connection <b>DX</b> code branchement <b>DX</b> Artikel Nr. anschliess <b>DX</b> codigo empalme <b>DX</b> код соединения <b>DX</b>	altezza height hauteur Höhe altura высота	larghezza width largeur Breite ancho ширина	interasse distance between bars entraxe Achsabstand distancia entre centros межцентровое расстояние	peso weight poids Gewicht peso вес	Watt = Kcal/h ÷ 0,860 Kcal/h = Watt × 0,860			prezzo/colori . price/colours . prix/couleurs Preis/Farben . precio/colores . цена/цвета			
						output мощность 75/65-20 watt*	output мощность 55/45-20 watt*	output мощность 55/45-24 watt*	bianco puro opaco pure white matt blanc pur mat mattes reines Weiß blanco puro mate чистый белый матовый RAL 9016 ...V € euro	gruppo group groupe Gruppe grupo группа A ...VC € euro	gruppo group groupe Gruppe grupo группа B ...VM € euro	gruppo group groupe Gruppe grupo группа C ...VS € euro
FBRASX1201...	FBRADX1201...	1200	230	50	12	380	200	167	1.260,00	1.512,00	1.575,00	1.764,00
FBRASX1202...	FBRADX1202...	1200	422	50	25	760	400	333	2.076,00	2.491,00	2.595,00	2.906,00
FBRASX1203...	FBRADX1203...	1200	614	50	37	1140	600	500	3.322,00	3.986,00	4.153,00	4.651,00
FBRASX1501...	FBRADX1501...	1500	230	50	15	490	258	215	1.308,00	1.570,00	1.635,00	1.831,00
FBRASX1502...	FBRADX1502...	1500	422	50	30,5	980	516	430	2.158,00	2.590,00	2.698,00	3.021,00
FBRASX1503...	FBRADX1503...	1500	614	50	45	1470	774	645	3.452,00	4.142,00	4.315,00	4.833,00
FBRASX1801...	FBRADX1801...	1800	230	50	17,5	590	311	259	1.380,00	1.656,00	1.725,00	1.932,00
FBRASX1802...	FBRADX1802...	1800	422	50	36,5	1180	621	518	2.280,00	2.736,00	2.850,00	3.192,00
FBRASX1803...	FBRADX1803...	1800	614	50	53,5	1770	932	777	3.762,00	4.514,00	4.703,00	5.267,00
FBRASX2001...	FBRADX2001...	2000	230	50	19,5	660	357	289	1.428,00	1.714,00	1.785,00	1.999,00
FBRASX2002...	FBRADX2002...	2000	422	50	40	1320	695	579	2.498,00	2.998,00	3.123,00	3.497,00
FBRASX2003...	FBRADX2003...	2000	614	50	59	1980	1042	868	4.122,00	4.946,00	5.153,00	5.771,00

- \* I watt hanno valori provvisori in attesa di certificazione Δt50.
- \* The watt values are not definitive awaiting for Δt50 certification.
- \* Le nombre de Watts est une valeur indiquée à titre provisoire dans l'attente de la certification Δt50.
- \* Die Wattwerte sind vorläufig bis zur Δt50 Zertifizierung.
- \* Los Vatios tienen valores provisionales en espera de la certificación Δt50.
- \* До получения сертификата Δt50 приводится предварительное значение мощности в ваттах.

Massima pressione di esercizio: 8 bar  
**Materiale: Alluminio**

Maximum working pressure: 8 bar.  
**Material: aluminium**

Pression d'exercice maximale: 8 bars  
**Matériel: aluminium**

Maximaler Betriebsdruck: 8 bar  
**Material: Aluminium**

Presion maxima de trabajo: 8 bar  
**Material: Aluminio**

Максимальное рабочее давление – 8 бар  
**Материал – алюминий**

Appendi accappatoio a richiesta  
Bathrobe hanger on request  
Porte-peignoir sur demande  
Bademantelaufhänger Optional  
Colgador albornoz bajo pedido  
Вешалка для халата по запросу

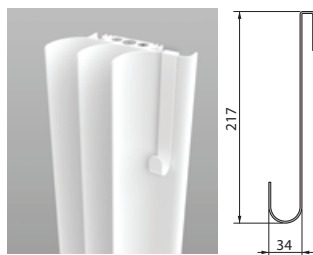

FBRA010

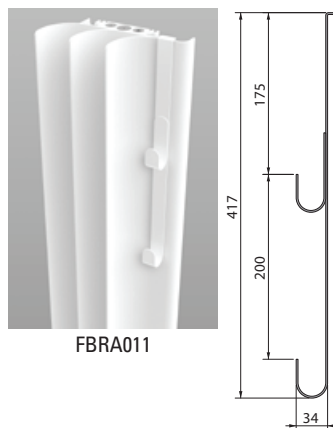

FBRA011

codice code code Artikel Nr. codigo код	altezza height hauteur Höhe altura высота	bianco puro opaco pure white matt blanc pur mat mattes reines Weiß blanco puro mate чистый белый матовый RAL 9016 € euro	gruppo group groupe Gruppe grupo группа A € euro	gruppo group groupe Gruppe grupo группа B € euro	gruppo group groupe Gruppe grupo группа C € euro
FBRA010	217	156,00	187,00	196,00	218,00
FBRA011	417	228,00	274,00	286,00	319,00

Barra portasciugamani a richiesta  
Towel rail on request  
Barre porte-serviettes sur demande  
Handtuchhalter Optional  
Toallero bajo pedido  
Полотенцедержатель по запросу



codice code code Artikel Nr. codigo код	larghezza width largeur Breite ancho ширина	bianco puro opaco pure white matt blanc pur mat mattes reines Weiß blanco puro mate чистый белый матовый RAL 9016 € euro	gruppo group groupe Gruppe grupo группа A € euro	gruppo group groupe Gruppe grupo группа B € euro	gruppo group groupe Gruppe grupo группа C € euro
FBRA020	254	192,00	230,00	240,00	269,00
FBRA021	382	264,00	317,00	330,00	370,00

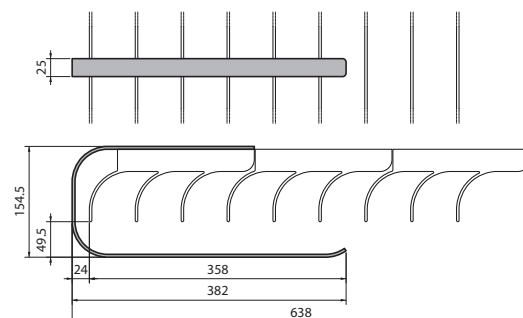
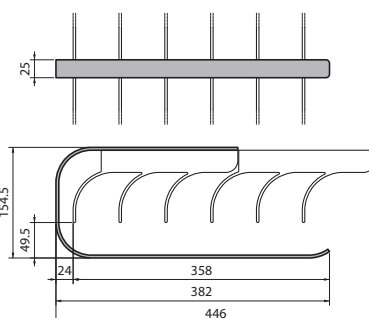
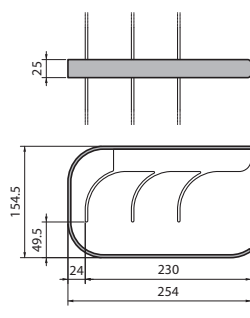

# BRASILIA VERTICAL ELEC

eco  
design



design by Massimo Iosa Ghini

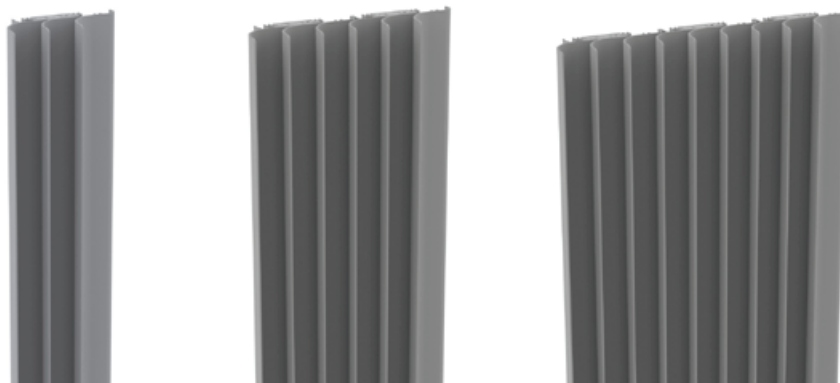

Interasse dal centro foro al muro 46 mm.  
Distance between hole center and wall 46 mm.  
Distance du centre du trou au mur 46 mm.  
Abstand zwischen Lochmitte und Wand 46 mm.  
Distancia entre el centro del agujero y el muro 46 mm.  
Расстояние между центром отверстия и стеной - 46 мм.

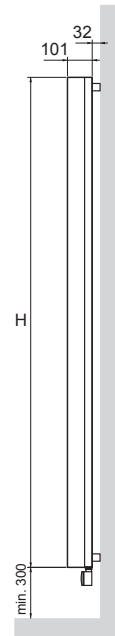
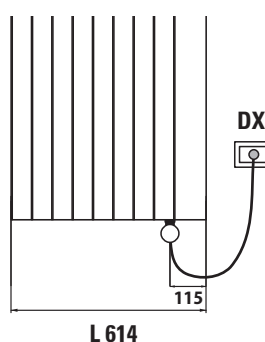
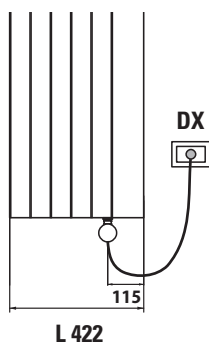
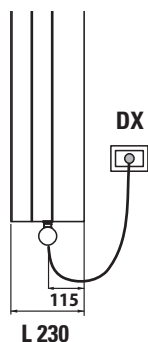

**A richiesta:** Copriresistenza nella stessa finitura del radiatore  
**On request:** Heating element cover as per radiator finish  
**Sur demande:** Couverture du thermostat dans la même finition du radiateur  
**Optional:** Heizstab Abdeckung in der gleichen Ausführung wie der Heizkörper  
**Bajo pedido:** Protección resistencia en el mismo acabado que el radiador  
**По запросу:** Цвет покрытия терморегулятора соответствует цвету радиатора

p./S. 379

a partire da - from - à partir de - ab - a partir de - or  
€ 87,00

- Mod SP1:** resistenza elettrica con infrarossi munita di telecomando di serie + cavo 1200mm + spina schuko+ glicole  
**Mod SP2:** resistenza elettrica con infrarossi CI.2 munita di telecomando + cavo 900mm + fil pilote + glicole. **Solo per il mercato francese**  
**Mod SP1 / SP2: programmazione giornaliera / settimanale**  
**Mod SP1:** infrared programmable thermostat as standard + cable 1200 mm + schuko plug + glycole  
**Mod SP2:** infrared programmable thermostat CI.2 + cable 900 mm + fil pilote + glycole. **Only for French market**  
**Mod SP1 / SP2: daily / weekly programming**  
**Mod SP1:** Thermostat programmable infra-rouge en série + câble 1200 mm + prose Schuko + glycol  
**Mod SP2:** Thermostat programmable infra-rouge CI.2 + câble 900 mm + fil pilote + glycol. **Pour le marché français seulement**  
**Mod SP1 / SP2: programmation journalière / hebdomadaire**  
**Mod SP1:** Heizstab mit Infrarot ausgeschattet mit Fernbedienung standardmäßig + 1200 mm Kabel + Schukostecker + Glykol  
**Mod SP2:** Heizstab mit Infrarot ausgeschattet mit Fernbedienung CI.2 + 900 mm Kabel + fil pilote + Glykol. **Nur für französischen Markt**  
**Mod SP1 / SP2: Tägliche / Wöchentliche Programmierung**  
**Mod SP1:** Resistencia eléctrica con infrarrojo provisto de control remoto de serie + 1200 mm cable + clavija schuko + glycole  
**Mod SP2:** Resistencia eléctrica con infrarrojo provisto de control remoto CI.2 + 900 mm cable + fil pilote + glycole. **Solo por mercado francés**  
**Mod SP1 / SP2: Programación diaria/semanal**  
**Mod SP1:** гинфракрасный программируемый термостат стандартный комплект поставки + кабель 1200мм + электрическая вилка + гликоль  
**Mod SP2:** гинфракрасный программируемый термостат класс II + кабель 900мм + гликоль. **Только для рынка Франции**  
**Mod SP1 / SP2: Дневное/недельное программирование**

**Mod. ER1 / ER2:** kit termostato ambiente con programmazione giornaliera / settimanale e ricevitore in radiofrequenza per scatola a muro (installazione obbligatoria). Copriresistenza nella stessa finitura del radiatore

**Mod. ER2: solo per il mercato francese**

**Mod. ER1 / ER2:** room thermostat kit with daily / weekly programming and wireless receiver for wall box (mandatory installation). Heating element cover as per radiator finish

**Mod. ER2: only for the French market**

**Mod. ER1/ER2:** kit de thermostat d'ambiance pour la programmation journalière / hebdomadaire et récepteur à radiofréquence pour connexion au mur (installation obligatoire). Couverture du thermostat dans la même finition du radiateur

**Mod. ER2: seulement pour le marché Français**

**Mod. ER1 / ER2:** Raumthermostat-Kit mit Tägliche / Wöchentlicher Programmierung und Hochfrequenzempfänger für Wandbox (obligatorische Installation). Heizstab Abdeckung in der gleichen Ausführung wie der Heizkörper

**Mod. ER2: nur für den französischen Markt**

**Mod. ER1 / ER2:** kit de termostato de ambiente con programación diaria / semanal y receptor de radiofrecuencia para caja de pared (instalación obligatoria). Protección resistencia en el mismo acabado que el radiador

**Mod. ER2: solo para el mercado francés**

**Mod. ER1 / ER2:** комплект комнатного термостата с Дневное / недельное программированием и беспроводным приемником для настенной коробки (обязательная установка). Цвет покрытия терморегулятора соответствует цвету радиатора

**Mod. ER2: только для французского рынка**

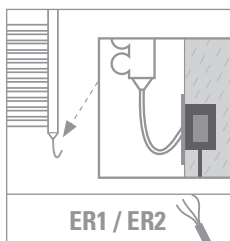
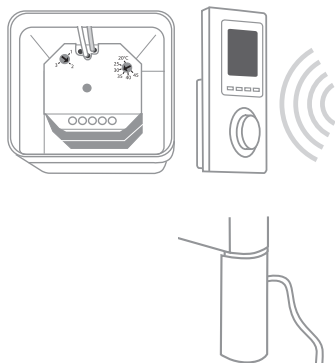

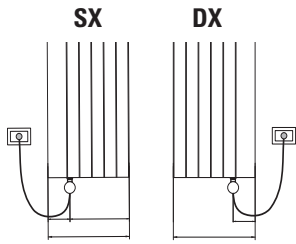

**Mod. SP1 / SP2**



**Mod.ER1 /ER2**



prezzo del radiatore + resistenza elettrica mod. SP1 - cl.1 / mod. SP2 - cl.2 + glicole  
 radiator price + heating element mod. SP1 - cl.1 / mod. SP2 - cl.2 + glycol  
 prix du radiateur + resistance electrique mod. SP1 - cl.1 / mod. SP2 - cl.2 + glycol  
 Heizkörperpreis inkl. Heizstab Elec mod. SP1 - cl.1 / mod. SP2 - cl.2 + Glykol  
 precio del radiadore + resistencia eléctrica mod. SP1 - cl.1 / mod. SP2 - cl.2 + glicole  
 цена радиатор + электротен мод. SP1 - cl.1 / mod. SP2 - cl.2 + гликоль

prezzo del radiatore + resistenza elettrica mod. ER1 - cl.1 / mod. ER2 - cl.2 + glicole  
 radiator price + heating element mod. ER1 - cl.1 / mod. ER2 - cl.2 + glycol  
 prix du radiateur + resistance electrique mod. ER1 - cl.1 / mod. ER2 - cl.2 + glycol  
 Heizkörperpreis inkl. Heizstab Elec mod. ER1 - cl.1 / mod. ER2 - cl.2 + Glykol  
 precio del radiadore + resistencia eléctrica mod. ER1 - cl.1 / mod. ER2 - cl.2 + glicole  
 цена радиатор + электротен мод. ER1 - cl.1 / mod. ER2 - cl.2 + гликоль

Watt = Kcal/h ÷ 0,860  
 Kcal/h = Watt × 0,860

codice allaccio SX code connection SX code branchement SX Artikel Nr. anschliess SX codigo empalme SX код соединения SX	codice allaccio DX code connection DX code branchement DX Artikel Nr. anschliess DX codigo empalme DX код соединения DX	altezza* height* hauteur* Höhe* altura* высота*	larghezza width largeur Breite ancho ширина	output versione elettrica version puissance en version electrique Output für elektrische Ausführung output versione agua electric выход электрического варианта	bianco puro opaco pure white matt blanc pur mat mattes reines Weiß blanco puro mate чистый белый матовый	RAL 9016	gruppo group groupe Gruppe grupo группа	gruppo group groupe Gruppe grupo группа	gruppo group groupe Gruppe grupo группа	gruppo group groupe Gruppe grupo группа	gruppo group groupe Gruppe grupo группа	gruppo group groupe Gruppe grupo группа	gruppo group groupe Gruppe grupo группа	gruppo group groupe Gruppe grupo группа	gruppo group groupe Gruppe grupo группа	gruppo group groupe Gruppe grupo группа
FBRASX1201...	FBRADX1201...	1280	230	400	2.040,00	2.292,00	2.355,00	2.544,00	2.268,00	2.520,00	2.583,00	2.772,00				
FBRASX1202...	FBRADX1202...	1280	422	700	2.856,00	3.271,00	3.375,00	3.686,00	3.084,00	3.499,00	3.603,00	3.914,00				
FBRASX1203...	FBRADX1203...	1280	614	1000	4.102,00	4.766,00	4.933,00	5.431,00	4.330,00	4.994,00	5.161,00	5.659,00				
FBRASX1501...	FBRADX1501...	1580	230	400	2.088,00	2.350,00	2.415,00	2.611,00	2.316,00	2.578,00	2.643,00	2.839,00				
FBRASX1502...	FBRADX1502...	1580	422	700	2.938,00	3.370,00	3.478,00	3.801,00	3.166,00	3.588,00	3.706,00	4.029,00				
FBRASX1503...	FBRADX1503...	1580	614	1000	4.232,00	4.922,00	5.095,00	5.613,00	4.460,00	5.150,00	5.323,00	5.841,00				
FBRASX1801...	FBRADX1801...	1880	230	700	2.160,00	2.436,00	2.505,00	2.712,00	2.388,00	2.664,00	2.733,00	2.940,00				
FBRASX1802...	FBRADX1802...	1880	422	1000	3.060,00	3.516,00	3.630,00	3.972,00	3.288,00	3.744,00	3.858,00	4.200,00				
FBRASX2001...	FBRADX2001...	2080	230	1000	2.208,00	2.494,00	2.565,00	2.779,00	2.436,00	2.722,00	2.793,00	3.007,00				
FBRASX2002...	FBRADX2002...	2080	422	1400	-	-	-	-	3.506,00	4.006,00	4.131,00	4.505,00				

- ♦ Incluso il termostato
- ♦ Included room control
- ♦ Inclus boîtier de régulation
- ♦ Inkl. Raumthermostat
- ♦ Incluido termostato por ambiente
- ♦ Включающая термостат

Scatola termostato bianca di serie per radiatori bianchi. Scatola termostato cromata di serie per radiatori colorati e finiture inox.  
 Standard white thermostat box for white radiators. Standard chromed thermostat box for coloured and stainless steel finishing radiators.  
 Boîtier thermostat blanc de série pour radiateurs blancs. Boîtier thermostat chromée de série pour radiateurs colorés et finitions inox.  
 Serienmäßig weißes Thermostatgehäuse für weiße Heizkörper. Serienmäßig verchromte Thermostatgehäuse für bunte Heizkörper und Edelstahlfinish.  
 Caja de termostato blanca de serie para radiadores blancos. Caja de termostato cromado de serie para radiadores coloreados y acabados inox.  
 Корпус термостата белый стандартный для белых радиаторов. Стандартный хромированный термостат для цветных радиаторов и радиаторов в отделке нержавеющей стали.

Appendi accappatoio a richiesta  
 Bathrobe hanger on request  
 Porte-peignoir sur demande  
 Bademantelaufhänger Optional  
 Colgador albornoz bajo pedido  
 Вешалка для халата по запросу

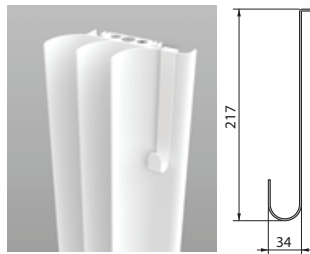

FBRA010

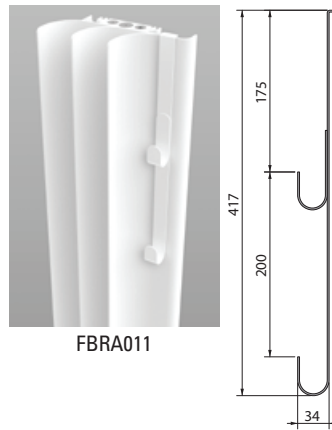

FBRA011

codice code code Artikel Nr. codigo код	altezza height hauteur Höhe altura высота	prezzo/colori . price/colours . prix/couleurs Preis/Farben . precio/colores . цена/цвета			
		bianco puro opaco pure white matt blanc pur mat mattes reines Weiß blanco puro mate чистый белый матовый	gruppo group groupe Gruppe grupo группа	gruppo group groupe Gruppe grupo группа	gruppo group groupe Gruppe grupo группа
	H mm	RAL 9016 € euro	A € euro	B € euro	C € euro
FBRA010	217	156,00	187,00	196,00	218,00
FBRA011	417	228,00	274,00	286,00	319,00

Barra portasciugamani a richiesta  
 Towel rail on request  
 Barre porte-serviettes sur demande  
 Handtuchhalter Optional  
 Toallero bajo pedido  
 Полотенцедержатель по запросу



codice code code Artikel Nr. codigo код	larghezza width largeur Breite ancho ширина	prezzo/colori . price/colours . prix/couleurs Preis/Farben . precio/colores . цена/цвета			
		bianco puro opaco pure white matt blanc pur mat mattes reines Weiß blanco puro mate чистый белый матовый	gruppo group groupe Gruppe grupo группа	gruppo group groupe Gruppe grupo группа	gruppo group groupe Gruppe grupo группа
	L mm	RAL 9016 € euro	A € euro	B € euro	C € euro
FBRA020	254	192,00	230,00	240,00	269,00
FBRA021	382	264,00	317,00	330,00	370,00

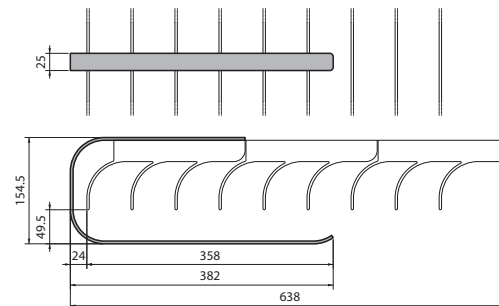
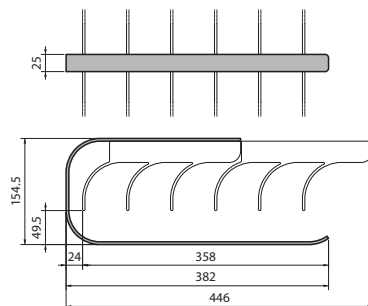
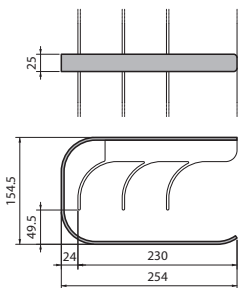

# BRASILIA HORIZONTAL



design by Massimo Iosa Ghini

Interasse dal centro foro al muro 46 mm.  
 Distance between hole center and wall 46 mm.  
 Distance du centre du trou au mur 46 mm.  
 Abstand zwischen Lochmitte und Wand 46 mm.  
 Distancia entre el centro del agujero y el muro 46 mm.  
 Расстояние между центром отверстия и стеной - 46 мм.

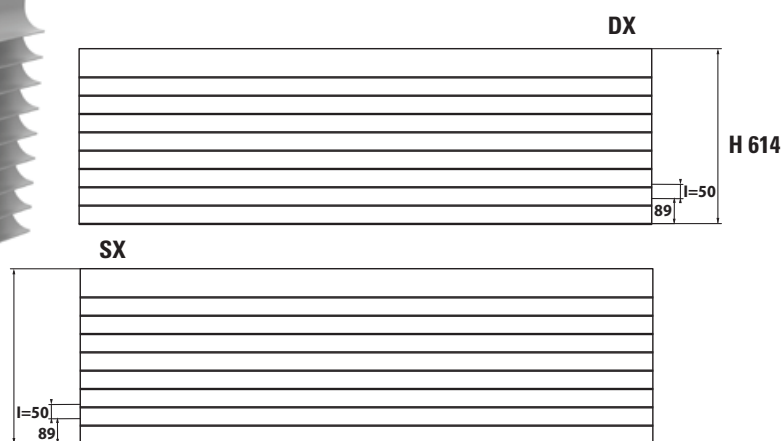
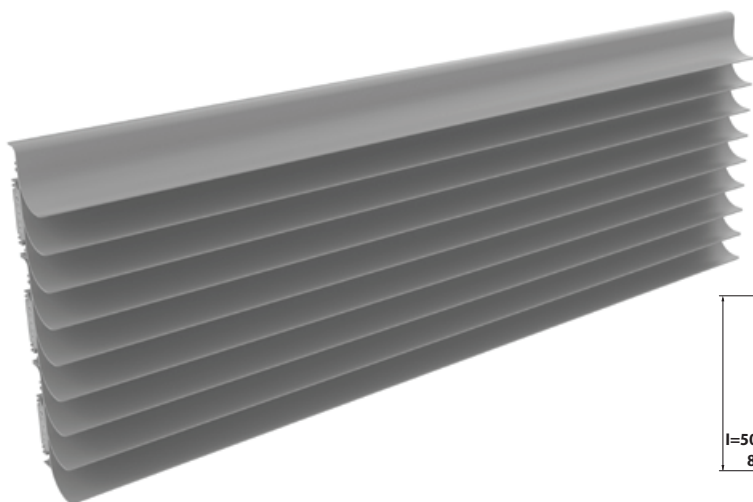
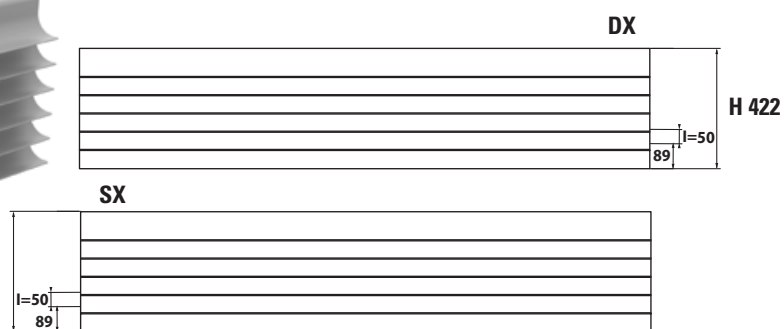
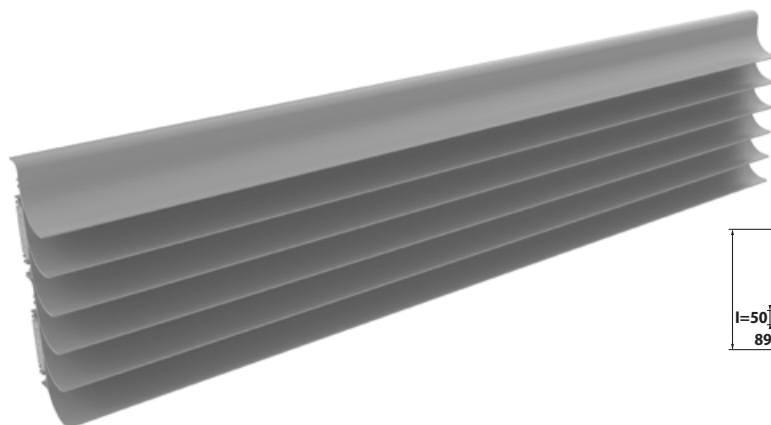
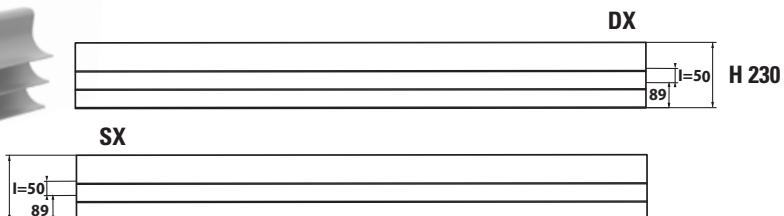
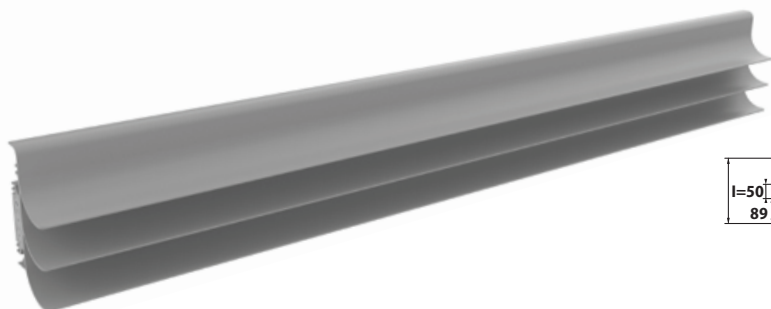
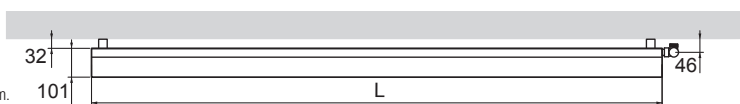

						Watt = Kcal/h - 0,860 Kcal/h = Watt x 0,860			prezzo/colori . price/colours . prix/couleurs Preis/Farben . precio/colores . цена/цвета			
codice allaccio <b>SX</b> code connection <b>SX</b> code branchement <b>SX</b> Artikel Nr. anschluss <b>SX</b> codigo empalme <b>SX</b> код соединения <b>SX</b>	codice allaccio <b>DX</b> code connection <b>DX</b> code branchement <b>DX</b> Artikel Nr. anschluss <b>DX</b> codigo empalme <b>DX</b> код соединения <b>DX</b>	larghezza width largeur Breite ancho ширина	altezza height hauteur Höhe altura высота	interasse distance between bars entraxe Achsabstand distancia entre centros межцентровое расстояние	peso weight poids Gewicht peso вес	output мощность	output мощность	output мощность	bianco puro opaco pure white matt blanc pur mat mattes reines Weiß blanco puro mate чистый белый матовый	gruppo group groupe Gruppe grupo группа	gruppo group groupe Gruppe grupo группа	gruppo group groupe Gruppe grupo группа
						75/65-20	55/45-20	55/45-24	RAL 9016	A	B	C
						watt*	watt*	watt*	...H € euro	...HC € euro	...HM € euro	...HS € euro
						Δt50	Δt30	Δt26				
FBRASX1201...	FBRADX1201...	1200	230	50	12	380	200	167	1.324,00	1.589,00	1.655,00	1.854,00
FBRASX1202...	FBRADX1202...	1200	422	50	25	760	400	333	2.180,00	2.616,00	2.725,00	3.052,00
FBRASX1203...	FBRADX1203...	1200	614	50	37	1140	600	500	3.487,00	4.184,00	4.359,00	4.882,00
FBRASX1501...	FBRADX1501...	1500	230	50	15	490	258	215	1.374,00	1.649,00	1.718,00	1.924,00
FBRASX1502...	FBRADX1502...	1500	422	50	30,5	980	516	430	2.266,00	2.719,00	2.833,00	3.172,00
FBRASX1503...	FBRADX1503...	1500	614	50	45	1470	774	645	3.625,00	4.350,00	4.531,00	5.075,00
FBRASX1801...	FBRADX1801...	1800	230	50	17,5	590	311	259	1.450,00	1.740,00	1.813,00	2.030,00
FBRASX1802...	FBRADX1802...	1800	422	50	36,5	1180	621	518	2.394,00	2.873,00	2.993,00	3.352,00
FBRASX1803...	FBRADX1803...	1800	614	50	53,5	1770	932	777	3.950,00	4.740,00	4.938,00	5.530,00
FBRASX2001...	FBRADX2001...	2000	230	50	19,5	660	357	289	1.500,00	1.800,00	1.875,00	2.100,00
FBRASX2001...	FBRADX2001...	2000	422	50	40	1320	695	579	2.623,00	3.148,00	3.279,00	3.672,00
FBRASX2001...	FBRADX2001...	2000	614	50	59	1980	1042	868	4.328,00	5.194,00	5.410,00	6.059,00

\* I watt hanno valori provvisori in attesa di certificazione Δt50.

\* The watt values are not definitive awaiting for Δt50 certification.

\* Le nombre de Watts est une valeur indiquée à titre provisoire dans l'attente de la certification Δt50.

\* Die Wattwerte sind vorläufig bis zur Δt50 Zertifizierung.

\* Los Vatios tienen valores provisionales en espera de la certificación Δt50.

\* До получения сертификата Δt50 приводится предварительное значение мощности в ваттах.

Massima pressione di esercizio: 8 bar  
**Materiale: Alluminio**

Maximum working pressure: 8 bar.  
**Material: aluminium**

Pression d'exercice maximale: 8 bars  
**Matériel: aluminium**

Maximaler Betriebsdruck: 8 bar  
**Material: Aluminium**

Presion maxima de trabajo: 8 bar  
**Material: Aluminio**

Максимальное рабочее давление – 8 бар  
**Материал – алюминий**

# BRASILIA WIDE VERTICAL



design by Massimo Iosa Ghini

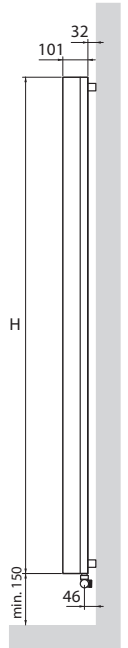
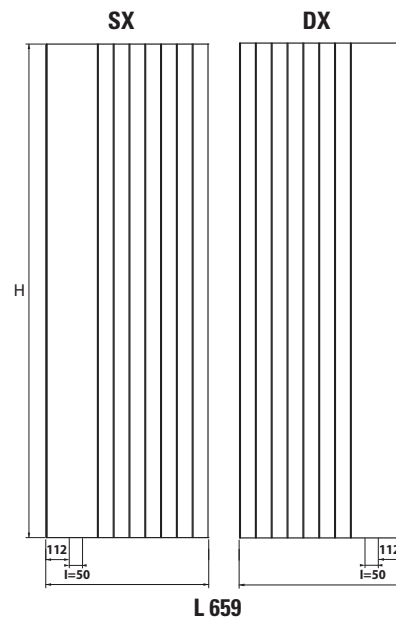
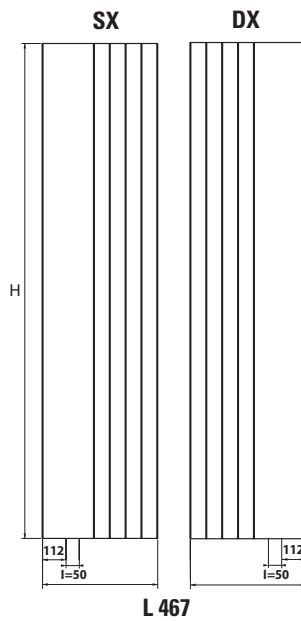
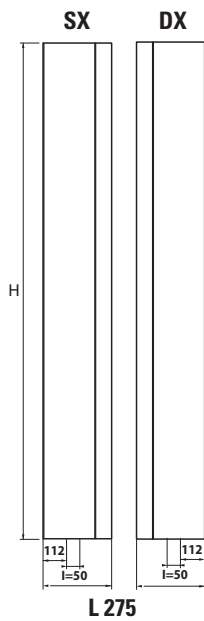
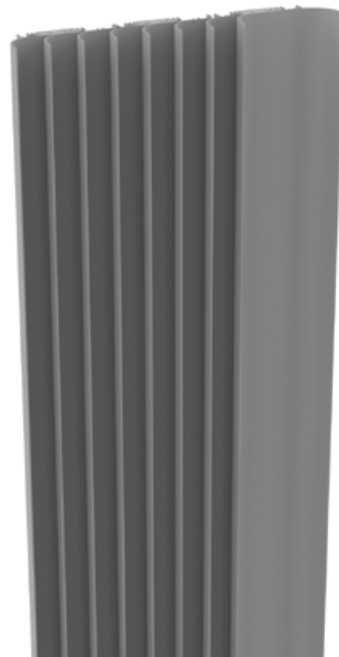

Interasse dal centro foro al muro 46 mm.  
 Distance between hole center and wall 46 mm.  
 Distance du centre du trou au mur 46 mm.  
 Abstand zwischen Lochmitte und Wand 46 mm.  
 Distancia entre el centro del agujero y el muro 46 mm.  
 Расстояние между центром отверстия и стеной - 46 мм.

codice allaccio SX code connection SX code branchement SX Artikel Nr. anschliess SX codigo empalme SX код соединения SX	codice allaccio DX code connection DX code branchement DX Artikel Nr. anschliess DX codigo empalme DX код соединения DX	altezza height hauteur Hohe altura высота	larghezza width largeur Breite ancho ширина	interasse distance between bars entraxe Achsabstand distancia entre centros межцентровое расстояние	peso weight poids Gewicht peso вес	Watt = Kcal/h ÷ 0,860 Kcal/h = Watt × 0,860			prezzo/colori . price/colours . prix/couleurs Preis/Farben . precio/colores . цена/цвета			
						output мощность watt*	output мощность watt*	output мощность watt*	bianco puro opaco pure white matt blanc pur mat mattes reines Weiß blanco puro mate чистый белый матовый RAL 9016	gruppo group group groupe Gruppe grupo группа A	gruppo group group groupe Gruppe grupo группа B	gruppo group group groupe Gruppe grupo группа C
FBRAWSX1201...	FBRAWDX1201...	1200	275	50	12	440	232	195	1.260,00	1.512,00	1.575,00	1.764,00
FBRAWSX1202...	FBRAWDX1202...	1200	467	50	25	820	432	363	2.076,00	2.491,00	2.595,00	2.906,00
FBRAWSX1203...	FBRAWDX1203...	1200	659	50	37	1200	632	533	3.322,00	3.986,00	4.153,00	4.651,00
FBRAWSX1501...	FBRAWDX1501...	1500	275	50	15	550	290	243	1.308,00	1.570,00	1.635,00	1.831,00
FBRAWSX1502...	FBRAWDX1502...	1500	467	50	30,5	1040	547	460	2.158,00	2.590,00	2.698,00	3.021,00
FBRAWSX1503...	FBRAWDX1503...	1500	659	50	45	1530	805	676	3.452,00	4.142,00	4.315,00	4.833,00
FBRAWSX1801...	FBRAWDX1801...	1800	275	50	17,5	660	347	292	1.380,00	1.656,00	1.725,00	1.932,00
FBRAWSX1802...	FBRAWDX1802...	1800	467	50	36,5	1250	658	553	2.280,00	2.736,00	2.850,00	3.192,00
FBRAWSX1803...	FBRAWDX1803...	1800	659	50	53,5	1840	968	813	3.762,00	4.514,00	4.703,00	5.267,00
FBRAWSX2001...	FBRAWDX2001...	2000	275	50	19,5	730	384	323	1.428,00	1.714,00	1.785,00	1.999,00
FBRAWSX2002...	FBRAWDX2002...	2000	467	50	40	1390	732	615	2.498,00	2.998,00	3.123,00	3.497,00
FBRAWSX2003...	FBRAWDX2003...	2000	659	50	59	2050	1079	908	4.122,00	4.946,00	5.153,00	5.771,00

- \* I watt hanno valori provvisori in attesa di certificazione Δt50.
- \* The watt values are not definitive awaiting for Δt50 certification.
- \* Le nombre de Watts est une valeur indiquée à titre provisoire dans l'attente de la certification Δt50.
- \* Die Wattwerte sind vorläufig bis zur Δt50 Zertifizierung.
- \* Los Vatios tienen valores provisionales en espera de la certificación Δt50.
- \* До получения сертификата Δt50 приводится предварительное значение мощности в ваттах.

Massima pressione di esercizio: 8 bar  
**Materiale: Alluminio**

Maximum working pressure: 8 bar.  
**Material: aluminium**

Pression d'exercice maximale: 8 bars  
**Matériel: aluminium**

Maximaler Betriebsdruck: 8 bar  
**Material: Aluminium**

Presion maxima de trabajo: 8 bar  
**Material: Aluminio**

Максимальное рабочее давление – 8 бар  
**Материал – алюминий**

Appendi accappatoio a richiesta  
Bathrobe hanger on request  
Porte-peignoir sur demande  
Bademantelaufhänger Optional  
Colgador albornojo bajo pedido  
Вешалка для халата по запросу

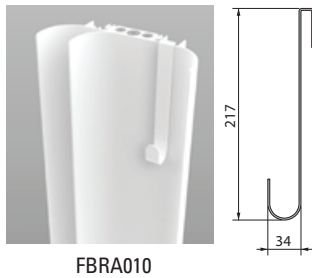

FBRA010

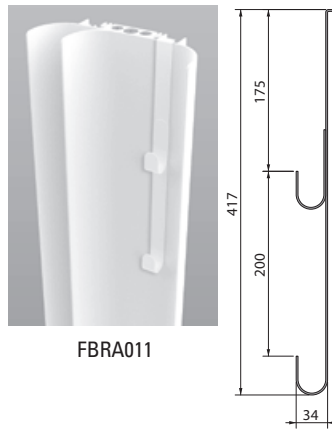

FBRA011

codice code code Artikel Nr. codigo код	altezza height hauteur Hohe altura высота	bianco puro opaco pure white matt blanc pur mat mattes reines Weiß blanco puro mate чистый белый матовый RAL 9016	gruppo group group groupe Gruppe grupo группа A	gruppo group group groupe Gruppe grupo группа B	gruppo group group groupe Gruppe grupo группа C	prezzo/colori . price/colours . prix/couleurs Preis/Farben . precio/colores . цена/цвета			
						H mm	€ euro	€ euro	€ euro
FBRA010	217	156,00	187,00	196,00	218,00				
FBRA011	417	228,00	274,00	286,00	319,00				

Barra portasciugamani a richiesta  
Towel rail on request  
Barre porte-serviettes sur demande  
Handtuchhalter Optional  
Toallero bajo pedido  
Полотенцедержатель по запросу



codice code code Artikel Nr. codigo код	larghezza width largeur Breite ancho ширина	bianco puro opaco pure white matt blanc pur mat mattes reines Weiß blanco puro mate чистый белый матовый RAL 9016	gruppo group group groupe Gruppe grupo группа A	gruppo group group groupe Gruppe grupo группа B	gruppo group group groupe Gruppe grupo группа C	prezzo/colori . price/colours . prix/couleurs Preis/Farben . precio/colores . цена/цвета			
						L mm	€ euro	€ euro	€ euro
FBRAW020	302	192,00	230,00	240,00	269,00				
FBRAW021	382	264,00	317,00	330,00	370,00				

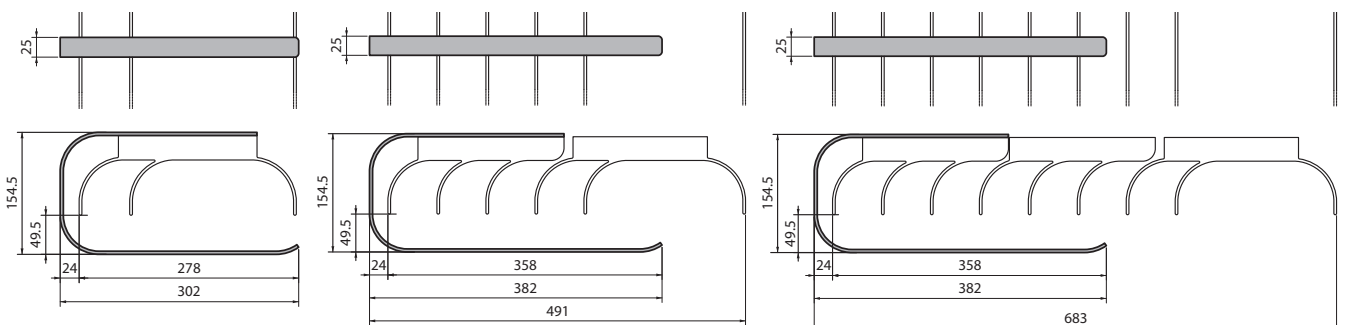



# BRASILIA WIDE VERTICAL ELEC

eco  
design



design by Massimo Iosa Ghini

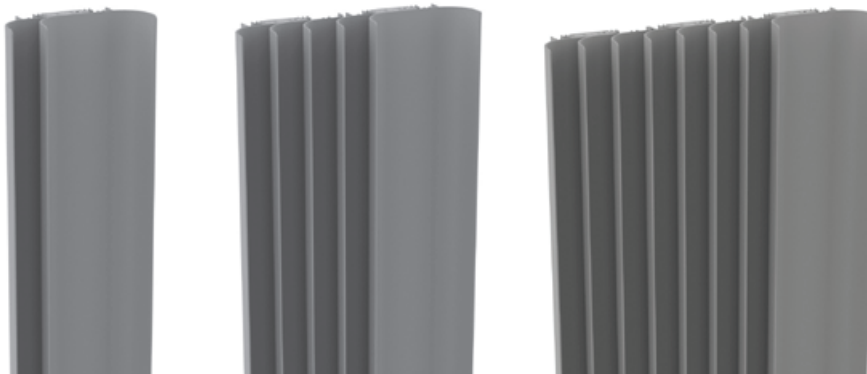

Interasse dal centro foro al muro 46 mm.  
Distance between hole center and wall 46 mm.  
Distance du centre du trou au mur 46 mm.  
Abstand zwischen Lochmitte und Wand 46 mm.  
Distancia entre el centro del agujero y el muro 46 mm.  
Расстояние между центром отверстия и стеной - 46 мм.



L 275

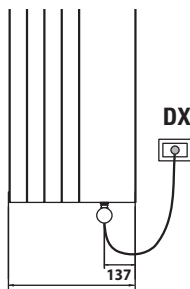

L 467

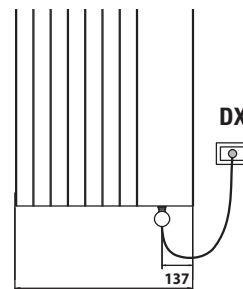

L 659

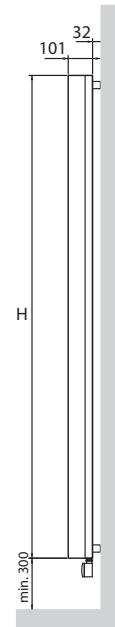

SP1 / SP2



**A richiesta:** Copriresistenza nella stessa finitura del radiatore  
**On request:** Heating element cover as per radiator finish  
**Sur demande:** Couverture du thermostat dans la même finition du radiateur  
**Optional:** Heizstab Abdeckung in der gleichen Ausführung wie der Heizkörper  
**Bajo pedido:** Protección resistencia en el mismo acabado que el radiador  
**По запросу:** Цвет покрытия терморегулятора соответствует цвету радиатора



a partire da - from - à partir de - ab - a partir de - or  
€ 87,00

- Mod SP1:** resistenza elettrica con infrarossi munita di telecomando di serie + cavo 1200mm + spina schuko+ glicole  
**Mod SP2:** resistenza elettrica con infrarossi CI.2 munita di telecomando + cavo 900mm + fil pilote + glicole. **Solo per il mercato francese**  
**Mod SP1 / SP2: programmazione giornaliera / settimanale**  
**Mod SP1:** infrared programmable thermostat as standard + cable 1200 mm + schuko plug + glycole  
**Mod SP2:** infraréd programmable thermostat CI.2 + cable 900 mm + fil pilote + glycole. **Only for French market**  
**Mod SP1 / SP2: daily / weekly programming**  
**Mod SP1:** Thermostat programmable infra-rouge en série + câble 1200 mm + prose Schuko + glycol  
**Mod SP2:** Thermostat programmable infra-rouge CI.2 + câble 900 mm + fil pilote + glycol. **Pour le marché français seulement**  
**Mod SP1 / SP2: programmation journalière / hebdomadaire**  
**Mod SP1:** Heizstab mit Infrarot ausgeschattet mit Fernbedienung standardmäßig + 1200 mm Kabel + Schukostecker + Glykol  
**Mod SP2:** Heizstab mit Infrarot ausgeschattet mit Fernbedienung CI.2 + 900 mm Kabel + fil pilote + Glykol. **Nur für französischen Markt**  
**Mod SP1 / SP2: Tägliche / Wöchentliche Programmierung**  
**Mod SP1:** Resistencia eléctrica con infrarrojo provisto de control remoto de serie + 1200 mm cable + clavija schuko + glycole  
**Mod SP2:** Resistencia eléctrica con infrarrojo provisto de control remoto CI.2 + 900 mm cable + fil pilote + glycole. **Sólo por mercado francés**  
**Mod SP1 / SP2: Programación diaria/semanal**  
**Mod SP1:** гинфракрасный программируемый термостат стандартный комплект поставки + кабель 1200мм + электрическая вилка + гликоль  
**Mod SP2:** гинфракрасный программируемый термостат класс II + кабель 900мм + гликоль. **Только для рынка Франции**  
**Mod SP1 / SP2: Дневное/недельное программирование**

**Mod. ER1 / ER2:** kit termostato ambiente con programmazione giornaliera / settimanale e ricevitore in radiofrequenza per scatola a muro (installazione obbligatoria). Copriresistenza nella stessa finitura del radiatore

**Mod. ER2: solo per il mercato francese**

**Mod. ER1 / ER2:** room thermostat kit with daily / weekly programming and wireless receiver for wall box (mandatory installation). Heating element cover as per radiator finish

**Mod. ER2: only for the French market**

**Mod. ER1/ER2:** kit de thermostat d'ambiance pour la programmation journalière / hebdomadaire et récepteur à radiofréquence pour connexion au mur (installation obligatoire). Couverture du thermostat dans la même finition du radiateur

**Mod. ER2: seulement pour le marché Français**

**Mod. ER1 / ER2:** Raumthermostat-Kit mit Tägliche / Wöchentlicher Programmierung und Hochfrequenzempfänger für Wandbox (obligatorische Installation). Heizstab Abdeckung in der gleichen Ausführung wie der Heizkörper

**Mod. ER2: nur für den französischen Markt**

**Mod. ER1 / ER2:** kit de termostato de ambiente con programación diaria / semanal y receptor de radiofrecuencia para caja de pared (instalación obligatoria). Protección resistencia en el mismo acabado que el radiador

**Mod. ER2: solo para el mercado francés**

**Mod. ER1 / ER2:** комплект комнатного термостата с Дневное / недельное программированием и беспроводным приемником для настенной коробки (обязательная установка). Цвет покрытия терморегулятора соответствует цвету радиатора

**Mod. ER2: только для французского рынка**

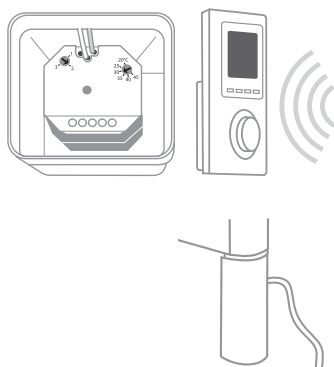

ER1 / ER2



SP1

SP2

**Mod. SP1 / SP2**



**Mod.ER1 /ER2**



prezzo del radiatore + resistenza elettrica mod. SP1 - cl.1 / mod. SP2 - cl.2 + glicole  
 radiator price + heating element mod. SP1 - cl.1 / mod. SP2 - cl.2 + glycol  
 prix du radiateur + resistance electrique mod. SP1 - cl.1 / mod. SP2 - cl.2 + glycol  
 Heizkörperpreis inkl. Heizstab Elec mod. SP1 - cl.1 / mod. SP2 - cl.2 + Glykol  
 precio del radiadore + resistencia eléctrica mod. SP1 - cl.1 / mod. SP2 - cl.2 + glicole  
 цена радиатор + электротен мод. SP1 - cl.1 / mod. SP2 - cl.2 + глицоль

prezzo del radiatore + resistenza elettrica mod. ER1 - cl.1 / mod. ER2 - cl.2 + glicole  
 radiator price + heating element mod. ER1 - cl.1 / mod. ER2 - cl.2 + glycol  
 prix du radiateur + resistance electrique mod. ER1 - cl.1 / mod. ER2 - cl.2 + glycol  
 Heizkörperpreis inkl. Heizstab Elec mod. ER1 - cl.1 / mod. ER2 - cl.2 + Glykol  
 precio del radiadore + resistencia eléctrica mod. ER1 - cl.1 / mod. ER2 - cl.2 + glicole  
 цена радиатор + электротен мод. ER1 - cl.1 / mod. ER2 - cl.2 + глицоль

Watt = Kcal/h ÷ 0,860  
 Kcal/h = Watt × 0,860

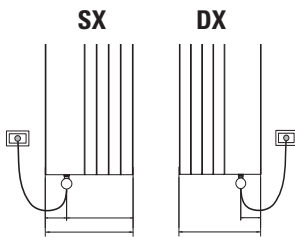

codice allaccio SX code connection SX code branchement SX Artikel Nr. anschliess SX codigo empalme SX код соединения SX	codice allaccio DX code connection DX code branchement DX Artikel Nr. anschliess DX codigo empalme DX код соединения DX	altezza* height* hauteur* Höhe* altura* высота*	larghezza width largeur Breite ancho ширина	output versione elettrica output for electrical version puissance en version electrique Output für elektrische Ausführung output versione agua electrica выход электрического варианта	bianco puro opaco pure white matt blanc pur mat mattes reines Weiß blanco puro mate чистый белый матовый	gruppo group groupe Gruppe grupo группа	gruppo group groupe Gruppe grupo группа	gruppo group groupe Gruppe grupo группа	bianco puro opaco pure white matt blanc pur mat mattes reines Weiß blanco puro mate чистый белый матовый	gruppo group groupe Gruppe grupo группа	gruppo group groupe Gruppe grupo группа	gruppo group groupe Gruppe grupo группа
				...VESP € euro	...VCESP € euro	...VMESP € euro	...VSESP € euro	...VEER € euro	...VCEER € euro	...VMEER € euro	...VSEER € euro	
FBRAWSX1201...	FBRAWDX1201...	1280	275	400	2.040,00	2.292,00	2.355,00	2.544,00	2.268,00	2.520,00	2.583,00	2.772,00
FBRAWSX1202...	FBRAWDX1202...	1280	467	700	2.856,00	3.271,00	3.375,00	3.686,00	3.084,00	3.499,00	3.603,00	3.914,00
FBRAWSX1203...	FBRAWDX1203...	1280	659	1000	4.102,00	4.766,00	4.933,00	5.431,00	4.330,00	4.994,00	5.161,00	5.659,00
FBRAWSX1501...	FBRAWDX1501...	1580	275	400	2.088,00	2.350,00	2.415,00	2.611,00	2.316,00	2.578,00	2.643,00	2.839,00
FBRAWSX1502...	FBRAWDX1502...	1580	467	700	2.938,00	3.370,00	3.478,00	3.801,00	3.166,00	3.588,00	3.706,00	4.029,00
FBRAWSX1503...	FBRAWDX1503...	1580	659	1000	4.232,00	4.922,00	5.095,00	5.613,00	4.460,00	5.150,00	5.323,00	5.841,00
FBRAWSX1801...	FBRAWDX1801...	1880	275	700	2.160,00	2.436,00	2.505,00	2.712,00	2.388,00	2.664,00	2.733,00	2.940,00
FBRAWSX1802...	FBRAWDX1802...	1880	467	1000	3.060,00	3.516,00	3.630,00	3.972,00	3.288,00	3.744,00	3.858,00	4.200,00
FBRAWSX2001...	FBRAWDX2001...	2080	275	1000	2.208,00	2.494,00	2.565,00	2.779,00	2.436,00	2.722,00	2.793,00	3.007,00
FBRAWSX2002...	FBRAWDX2002...	2080	467	1400	-	-	-	-	3.506,00	4.006,00	4.131,00	4.505,00

- Incluso il termostato
- Included room control
- Inclus boîtier de régulation
- Inkl. Raumthermostat
- Incluido termostato por ambiente
- Включающая термостат

Scatola termostato bianca di serie per radiatori bianchi. Scatola termostato cromata di serie per radiatori colorati e finiture inox.  
 Standard white thermostat box for white radiators. Standard chromed thermostat box for coloured and stainless steel finishings radiators.  
 Boîtier thermostat blanc de série pour radiateurs blancs. Boîtier thermostat chromée de série pour radiateurs colorés et finitions inox.  
 Serienmäßig weißes Thermostatgehäuse für weiße Heizkörper. Serienmäßig verchromte Thermostatgehäuse für bunte Heizkörper und Edelstahlfinish.  
 Caja de termostato blanca de serie para radiadores blancos. Caja de termostato cromado de serie para radiadores coloreados y acabados inox.  
 Корпус термостата белый стандартный для белых радиаторов. Стандартный хромированный термостат для цветных радиаторов и радиаторов в отделке нержавеющей стали.

Appendi accappatoio a richiesta  
 Bathrobe hanger on request  
 Porte-peignoir sur demande  
 Bademantelaufhänger Optional  
 Colgador albornoz bajo pedido  
 Вешалка для халата по запросу

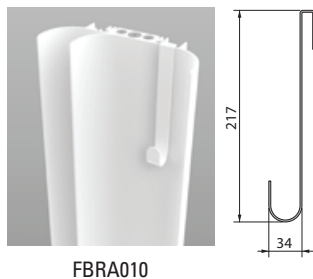

FBRA010

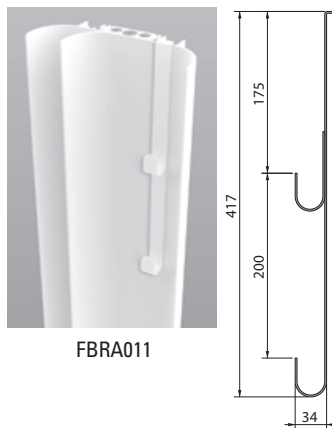

FBRA011

		prezzo/colori . price/colours . prix/couleurs Preis/Farben . precio/colores . цена/цвета			
codice code code Artikel Nr. codigo код	altezza height hauteur Höhe altura высота	bianco puro opaco pure white matt blanc pur mat mattes reines Weiß blanco puro mate чистый белый матовый	gruppo group groupe Gruppe grupo группа	gruppo group groupe Gruppe grupo группа	gruppo group groupe Gruppe grupo группа
		RAL 9016	A	B	C
		€ euro	€ euro	€ euro	€ euro
FBRA010	217	156,00	187,00	196,00	218,00
FBRA011	417	228,00	274,00	286,00	319,00

Barra portasciugamani a richiesta  
 Towel rail on request  
 Barre porte-serviettes sur demande  
 Handtuchhalter Optional  
 Toallero bajo pedido  
 Полотенцедержатель по запросу



		prezzo/colori . price/colours . prix/couleurs Preis/Farben . precio/colores . цена/цвета			
codice code code Artikel Nr. codigo код	larghezza width largeur Breite ancho ширина	bianco puro opaco pure white matt blanc pur mat mattes reines Weiß blanco puro mate чистый белый матовый	gruppo group groupe Gruppe grupo группа	gruppo group groupe Gruppe grupo группа	gruppo group groupe Gruppe grupo группа
		RAL 9016	A	B	C
		€ euro	€ euro	€ euro	€ euro
FBRAW020	302	192,00	230,00	240,00	269,00
FBRAW021	382	264,00	317,00	330,00	370,00

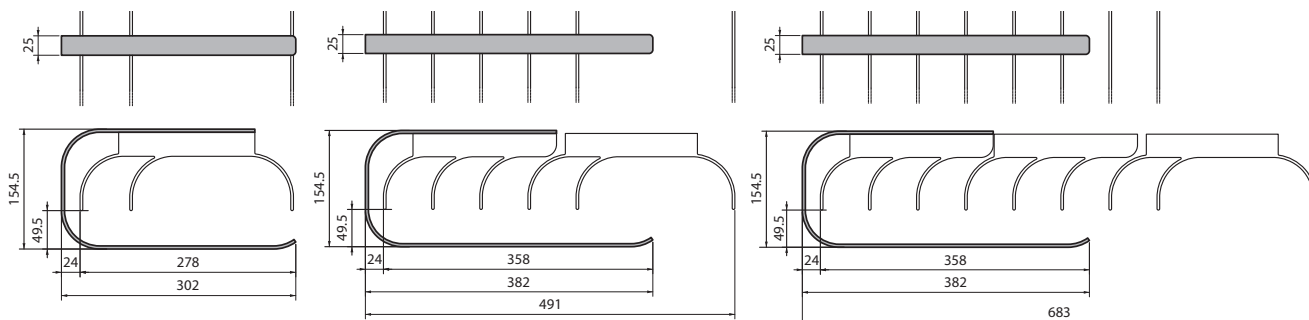

# COLORI DESIGN COLLECTION

COLOURS / COULEURS / FARBEN / COLORES / ЦВЕТА

## STANDARD DESIGN COLLECTION . СТАНДАРТНЫЕ DESIGN COLLECTION



9016 RAL bianco puro opaco / matt pure white / blanc pur mat / mattes reines Weiß / blanco puro mate / чистый матовый белый

## GRUPPO A - GROUP A - GROUPE A - GRUPPE A - GRUPO A - ГРУППА А



bianco B7 ruvido opaco / matt rough white B7 / blanc B7 rugueux mat / mattes grobes Weiß B7 / blanco B7 rugoso mate / белый B7 неоднородный

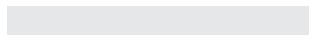

9002 RAL bianco grigiastro opaco / matt greyish white / blanc grisâtre mat / mattes gräuliches Weiß / blanco grisáceo mate / серо-белый матовый

NEWS



7038 RAL grigio agata opaco / matt agate grey / gris agate mat / mattes Achatgrau / gris ágata mate / серый агат матовый

NEWS



7030 RAL grigio pietra opaco / matt stone grey / gris pierre mat / mattes Steingrau / gris piedra mate / серый камень матовый



7044 RAL grigio marrone opaco / matt brown grey / gris marron mat / mattes Braungrau / gris marrón mate / Коричнево-серый матовый



7035 RAL manhattan opaco / matt manhattan / manhattan mat / mattes manhattan / manhattan mate / manhattan матовый



7045 RAL grigio opaco / matt grey / gris mat / mattes Grau / gris mate / Серый матовый



7015 RAL grigio ardesia opaco / matt slate grey / gris ardoise mat / mattes Schiefergrau / gris pizarra mate / серый сланец матовый



7016 RAL grigio antracite opaco / matt anthracite grey / gris anthracite mat / mattes Anthrazitgrau / gris antracita mate / серый свинцовый матовый



9001 RAL pergamon bianco opaco / matt pergamon white / blanc pergamon mat / mattes Pergamon-Weiß / blanco pergamon mate / белый пергаментный

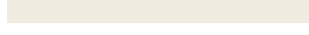

1013 RAL avorio opaco / matt ivory / ivoire mat / mattes elfenbein / marfil mate / слоновая кость матовый

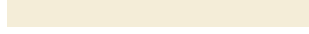

1015 RAL avorio chiaro opaco / matt light ivory / ivoire clair mat / mattes helles Elfenbein / marfil claro mate / цвет слоновой кости светлый матовый



1019 RAL beige grigiastro opaco / matt grey beige / beige gris mat / Mattes Graubeige / beis grisáceo mate / Бежево-серый матовый



7033 RAL grigio verdastro opaco / matt greenish grey / gris verdâtre mat / mattes grünliches Grau / gris verdoso mate / Зеленовато-серый матовый



7031 RAL blu grigiastro opaco / matt greyish blue / blue grisâtre mat / mattes gräuliches Blau / azul grisáceo mate / серо-синий матовый



5014 RAL colomba opaco / matt blue pigeon / blue pigeon mat / mattes taubenblau / azul colombino mate / сизый матовый

NEWS



3016 RAL rosso corallo opaco / matt coral red / rouge corail mat / mattes Korallenrot / rojo coral mate / красный коралл матовый



3004 RAL rosso porpora opaco / matt purple red / rouge pourpre mat / mattes Purpurrot / rojo púrpura mate / пурпурно-красный



7006 RAL grigio tela opaco / matt canvas grey / gris toile mat / Mattes Leinwandgrau / gris tela mate / Серо-полотняной матовый



8019 RAL marrone grigiastro opaco / matt grey brown / marron gris mat / Mattes Graubraun / marrón grisáceo mate / Коричнево-серый матовый



7021 RAL grigio nerastro opaco / matt blackish grey / gris foncé mat / mattes Schwarzgrau / gris negruzco mate / серый антрацитовый матовый



nero N4 ruvido opaco / matt rough black N4 / noir N4 rugueux mat / mattes grobes Schwarz N4 / Negro N4 rugoso mate / черный N4 неоднородный



9005 RAL nero intenso opaco / matt deep black / noir profond mat / mattes sattes Schwarz / negro intenso mate / черный насыщенный

## GRUPPO B - GROUP B - GROUPE B - GRUPPE B - GRUPO B - ГРУППА В

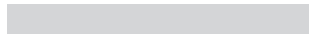

met iron BD RAG ruvido opaco / matt met iron BD RAG rough / fer métallisé BD RAG rugueux mat / met iron BD RAG mattes grob / hierro metalizado BD RAG rugoso mate / металлический BD RAG неоднородный



met grigio 3 RAG ruvido opaco / matt met grey 3 RAG rough / gris métallisé 3RAG rugueux mat / met grau 3 RAG mattes grob / gris metalizado BD RAG rugoso mate / серый металлический 3 RAG неоднородный матовый

NEWS



7015 RAL grigio ardesia opaco ruvido / rough matt slate grey / gris ardoise mat rugueux / mattes raues Schiefergrau / gris pizarra mate rugoso / серый сланец матовый шершавый

## GRUPPO C - GROUP C - GROUPE C - GRUPPE C - GRUPO C - ГРУППА С



9022 RAL pearl light grey, gris perle claire, helles Perlgrau, gris perla claro / Перламутровый светло-серый



verniciato satinato opaco / matt painted satined / peint satiné mat / mattes lackiert satiniert / pintado satinado mate / лакированный сатиновый матовый



1036 RAL oro perla opaco / matt pearl gold / or perle mat / mattes perle gold / oro perlado mate / жемчужный золотой



7048 RAL pearl mouse grey / gris souris nacré / Perlmausgrau / gris musgo perlado / Перламутровый мышино-серый



9007 RAL alluminio satinato opaco / aluminium painted satined matt / Aluminium peint satiné mat / Aluminium mattes lackiert satiniert / aluminio pintado satinado mate / алюминиевый сатиновый



marrone satinato / satined brown / marron satiné / Braun satiniert / marrón satinado / коричневый сатиновый

# COLORI STILUS - FINITURE SPECIALI

## ONLY FOR STILUS COLLECTION





COLOURS STILUS / COULEURS STILUS / FARBEN STILUS / COLORES STILUS / ЦВЕТА STILUS

	biotite
	dark bronze
	titanio
	palladio
	platino
	ambra

# COLORI BENT

## ONLY FOR BENT COLLECTION

COLOURS BENT / COULEURS BENT / FARBEN BENT / COLORES BENT / ЦВЕТА BENT

	bianco B7 ruvido opaco / matt rough white B7 / blanc B7 rugueux mat / mattes grobes Weiß B7 / blanco B7 rugoso mate / белый B7 неоднородный
	met iron BD RAG ruvido opaco / matt met iron BD RAG rough / fer métallisé BD RAG rugueux mat / met iron BD RAG mattes grob / hierro metalizado BD RAG rugoso mate / металлический BD RAG неоднородный
	met grigio 3 RAG ruvido opaco / matt met grey 3 RAG rough / gris métallisé 3RAG rugueux mat / met grau 3 RAG mattes grob / gris metalizado BD RAG rugoso mate / серый металлический 3 RAG неоднородный матовый
	nero N4 ruvido opaco / matt rough black N4 / noir N4 rugueux mat / mattes grobes Schwarz N4 / Negro N4 rugoso mate / черный N4 неоднородный
	7015 RAL grigio ardesia opaco ruvido / rough matt slate grey / gris ardoise mat rugueux / mattes raues Schiefergrau / gris pizarra mate rugoso / серый сланец матовый шершавый

# COLORI INOX

## ONLY FOR ICE COLLECTION

COLOURS INOX / COULEURS INOX / FARBEN INOX / COLORES INOX / ЦВЕТА INOX

GRUPPO INOX - GROUP INOX - GROUPE INOX - GRUPPE INOX - GRUPO INOX - ГРУППА INOX

	Gold finish
	Inox reflex
	Inox satinato

# COLORI HONEY

## ONLY FOR HONEY COLLECTION

COLOURS HONEY / COULEURS HONEY / FARBEN HONEY / COLORES HONEY / ЦВЕТА HONEY

	7035 RAL manhattan opaco / matt manhattan / manhattan mat / mattes manhattan / manhattan mate / manhattan матовый
	7045 RAL grigio opaco / matt grey / gris mat / mattes Grau / gris mate / Серый матовый
	7031 blu grigiastro opaco / matt greyish blue / blue grisâtre mat / mattes gräuliches Blau / azul grisáceo mate / серо-синий матовый
	7016 RAL grigio antracite opaco / matt anthracite grey / gris anthracite mat / mattes anthrazitgrau / Gris antracita mate / серый свинцовый матовый

VERNICIATURA A FORNO CON POLVERI EPOSSIDICHE / EPOXY-RESIN COATING / PEINTURE AU FOUR AUX POUDRES ÉPOXY / EINBRENNLACKIERUNG MIT EPOXIDPULVERN / BARNIZADO A HORNO CON POLVO EPOXICO / АНТИКОРРОЗИОННАЯ ПОРОШКОВАЯ ОКРАСКА

**!** **Attenzione:** La tonalità dei colori è indicativa pertanto fare sempre riferimento al colore del RAL reale  
**Attention:** please note that the colour of the finished radiator may be very slightly from the colour here represented; please refer always to the real RAL colour  
**Attention:** la nuance des couleurs est indicative; donc il faut toujours vérifier le couleur RAL real.  
**Achtung:** def Farbthton ist nur zur Demonstration; bitte immer auf die reale RAL Farbe sich beziehen .  
**Cuidado:** la tonalidad del color es indicativa; Conviene referirse siempre al RAL real  
**Внимание:** обращаем ваше внимание, что цвет готового радиатора может немного отличаться от цвета, представленного здесь; пожалуйста пользуйтесь всегда реальными цветами раскладки Ral.